



Accu-Sort as the leader in fixed position bar code scanners, offers the Model 20 Series II in its line of inexpensive moving beam scanners.

The combination of die cast zinc-aluminum endcaps and an extruded body yields a strong enclosure for applications requiring durability. The three point mounting feature on the base and the side is incorporated in the product to create repeatable mounting in any application. Optional configurations provide high density, long range or high speed capabilities.

The Model 20II's state-of-the-art scanning optics are designed to take the guesswork out of fixed position scanning applications. The unit's flexibility and performance allow it to read the most commonly used bar code densities at pre-defined mounting distances.

Using surface mount technology, a solid-state laser, and a brushless DC motor, we have designed a scanning system into one of the smallest packages available. The NEMA 12 extruded aluminum enclosure measures just 2.6 x 2.3 x 1.6 inches (6.6 x 5.8 x 4.1 cm) and provides protection for internal components in almost any harsh industrial environment.

The Model 20II uses an advanced RISC microprocessor to decode scanned data at very high rates and perform various application functions. The standard configuration provides 13 code types with autodiscrimination of eight bar code symbologies at once. Two parallel outputs selectable for valid and non-valid codes provide external signals to operate small relays.





Our Accu-Setup Suite program provides easy-to-use Windows®-based scanner setup (terminal or host on-line commands are also available). The Model 20 communicates to the host via RS-232-C, RS-422, RS-485 multidrop, or optional 20mA current loop (active or passive).

The compact Model 20 optical decoding and I/O features can accommodate a wide variety of scanning applications. Its small size and single power source enable easy integration into automatic test equipment, blood and chemical analyzers, document scanning systems, print verification, or any fixed position bar code scanning application requiring low-cost non-contact bar code scanners.

Typical applications include:

- Automated and manual medical specimen tracking
- Package content verification
- Automated document handling
- Bar code verification during the printing and binding process

OUTSTANDING FEATURES

-  **Compact size and integrated decoder allow for easy integration even in the tightest spaces**
-  **High scan rate increases flexibility, productivity, and efficiency**
-  **Wide scan angle allows bar code scanning even at a close distance**
-  **Reads all bar code densities at a pre-determined mounting distance without the need for optical adjustment**
-  **Optional EM-50 expansion module provides power and terminal block connections**

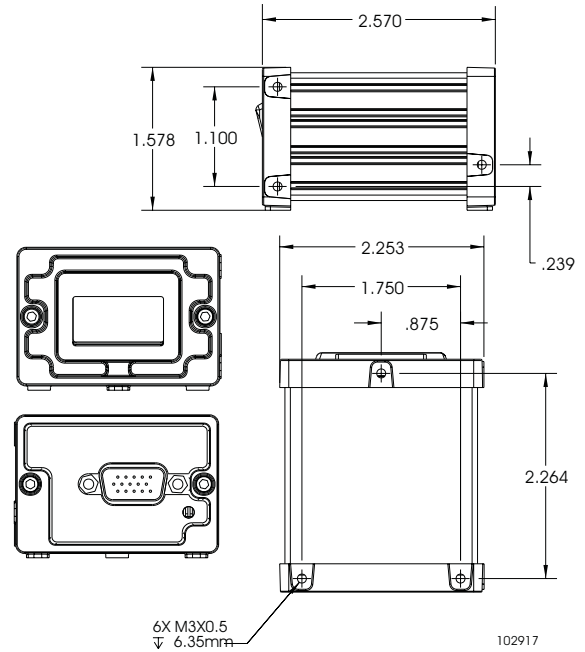
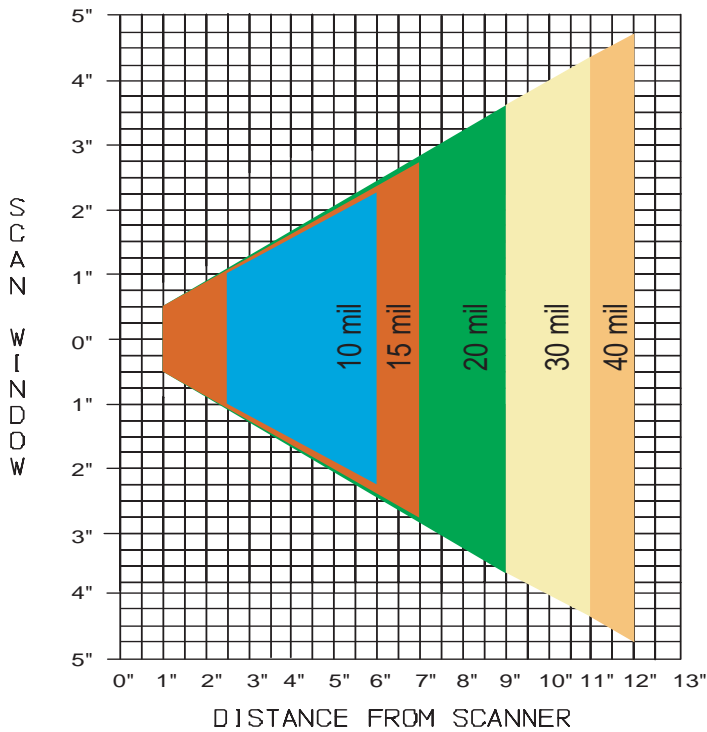

Note: This chart shows reading characteristics for the standard Model 20II-A only. Other models are Model 20II-B (High Density) and Model 20II-C (High Speed) and Model 20II-D (Long Range). For further information about other configurations, please contact your Accu-Sort sales representative.

Product Specifications



LASER LIGHT
DO NOT STARE INTO THE BEAM
CLASS 2 LASER PRODUCT
(IEC-60825-1)
CLASS II LASER PRODUCT
(21CFR1040)
≤2.15 mW PEAK @ 630-700nm

Scan Rate:

500 scans per second (standard)
300 scans per second (high density)
700 scans per second (high speed)
500 scans per second (long range)

Depth of Field:

See above

Laser Type:

Visible laser diode 650nm (standard)

Visual Diagnostics:

Power, trigger, laser, go/no read

Bar Code Types:

All standard 1D symbologies

Connectors:

Power
Photoeye
Communications
15-pin connector

Size:

Length - 2.6" (6.6 cm)
Width - 2.3" (5.8 cm)
Height - 1.6" (4.1 cm)

Weight:

5 oz (140 g)

Temperature Range:

32°-104°F (0°-40°C)

Relative Humidity:

10%-90% non-condensing

Enclosure:

NEMA 12 standard

Power:

5 VDC @ 500 mA

Communications:

Programmable I/O
RS-232
RS-422
RS-485
Current loop (with interface box option)
DeviceNet (with EM50II option)

Options:

Interface box with relays
Patented DRX (Data Reconstruction)
Presence detector
Power supply
Raster mirror wheel

Approvals:

UL, cUL, CE
CDRH
IEC-60825-1 Class 2

Service Options:

Installation assistance
On-site training

Warranty:

1-year limited, parts and labor

Accu-Sort reserves the right to change specifications without notice

Accu-Sort® Systems, inc. • 511 School House Road • Telford • PA • 18969

800-BAR-CODE • 215-723-0981 • fax 215-996-8249 • info@accusort.com • www.accusort.com



rev. 2.0 10/02